

Miniature solid-state relay - OPT-24DC/ 24DC/ 2



2966595

<https://www.phoenixcontact.com/pc/products/2966595>

Please be informed that the data shown in this PDF document is generated from our Online Catalog. Please find the complete data in the user documentation. Our General Terms of Use for Downloads are valid.

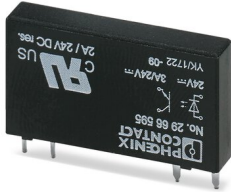

Plug-in miniature solid-state relay, power solid-state relay, 1 N/O contact, input: 24 V DC, output: 3 ... 33 V DC/3 A

Your advantages

- Vibration and shock resistant
- RT III-proof (wash-proof)
- Wear-free and durable
- Can be soldered on PCB
- Switching capacity of up to 24 V DC/3 A

Commercial Data

Item number	2966595
Packing unit	10 pc
Minimum order quantity	10 pc
Sales Key	08
Product Key	CK61F2
Catalog Page	Page 286 (C-5-2019)
GTIN	4017918130947
Weight per Piece (including packing)	5.26 g
Weight per Piece (excluding packing)	5.2 g
Customs tariff number	85364190
Country of origin	HU

Miniature solid-state relay - OPT-24DC/ 24DC/ 2



2966595

<https://www.phoenixcontact.com/pc/products/2966595>

Technical Data

Product properties

Product type	Single solid-state relay
Set comprises	2905293 RIF-0-OPT-24DC/24DC/2
	2905657 RIF-0-OSC-24DC/24DC/2
Operating mode	100% operating factor

Insulation characteristics

Overvoltage category	III
Pollution degree	2
Insulation	Basic insulation

Electrical properties

Maximum power dissipation for nominal condition	0.17 W
Test voltage Input/output	2.5 kV (50 Hz, 1 min., input/output)

Input data

Nominal input voltage U_N	24 V DC
Input voltage range in reference to U_N	0.8 ... 1.2
Input voltage range	19.2 V DC ... 28.8 V DC
Switching threshold "0" signal, voltage	≤ 10 V
Switching threshold "1" signal voltage	≥ 16 V
Typical input current at U_N	7 mA
Typical response time	20 μ s (at U_N)
Typical turn-off time	300 μ s (at U_N)
Transmission frequency	300 Hz

Output data

Contact type	1 N/O contact
Design of digital output	electronic
Output voltage range	3 V DC ... 33 V DC
Limiting continuous current	3 A (see derating curve)
Maximum inrush current	15 A (10 ms)
Voltage drop at max. limiting continuous current	≤ 150 mV
Output circuit	2-conductor, floating
Protective circuit	Reverse polarity protection
	Surge protection

Dimensions

Miniature solid-state relay - OPT-24DC/ 24DC/ 2



2966595

<https://www.phoenixcontact.com/pc/products/2966595>

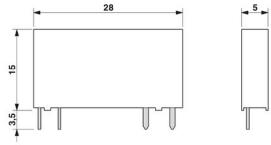
Dimensional drawing	
Width	5 mm
Height	28 mm
Depth	15 mm

Environmental and real-life conditions

Ambient conditions

Degree of protection	RT III
Ambient temperature (operation)	-25 °C ... 60 °C
Ambient temperature (storage/transport)	-25 °C ... 70 °C

Approval data

Corrosive gas test

Identification	ISA-S71.04. G3 Harsh Group EN 60068-2-60
----------------	---

Standards and regulations

Standards/regulations

Standards/regulations	IEC 60664 EN 50178
-----------------------	-----------------------

Mounting

Assembly instructions	in rows with zero spacing
Mounting position	any

Drawings

Diagram

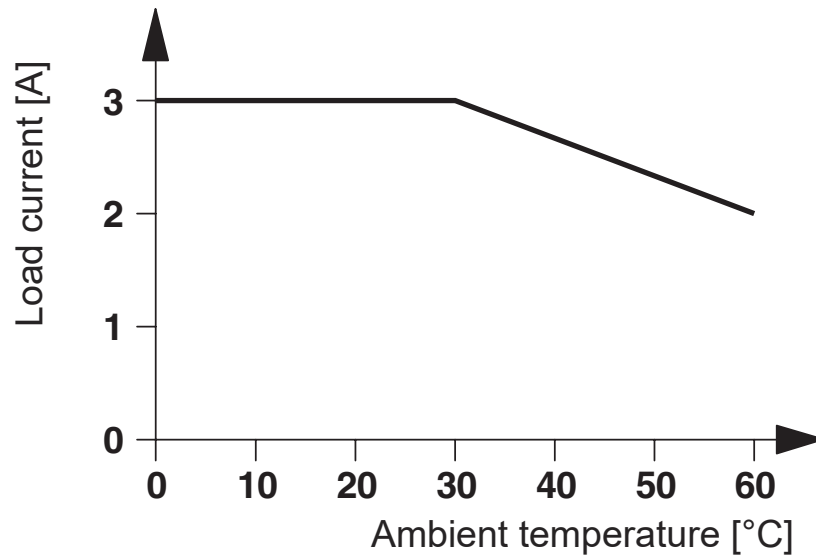

Circuit diagram

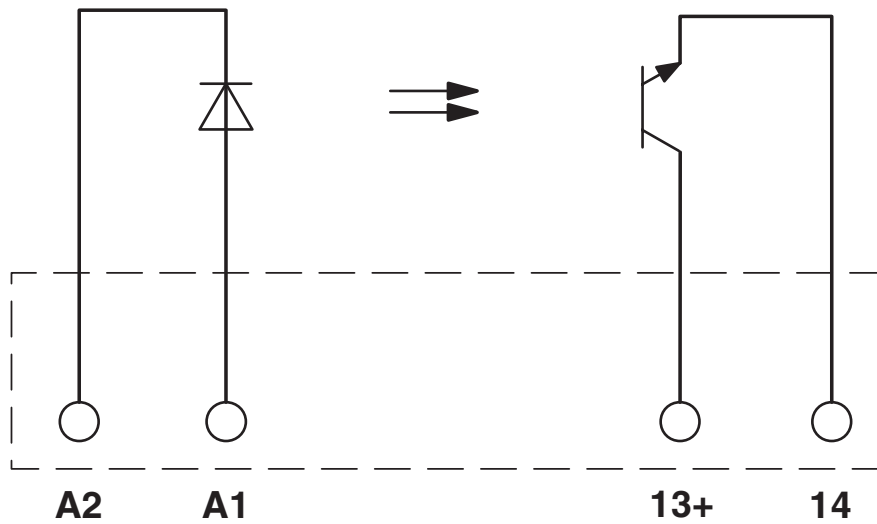

Miniature solid-state relay - OPT-24DC/ 24DC/ 2



2966595

<https://www.phoenixcontact.com/pc/products/2966595>

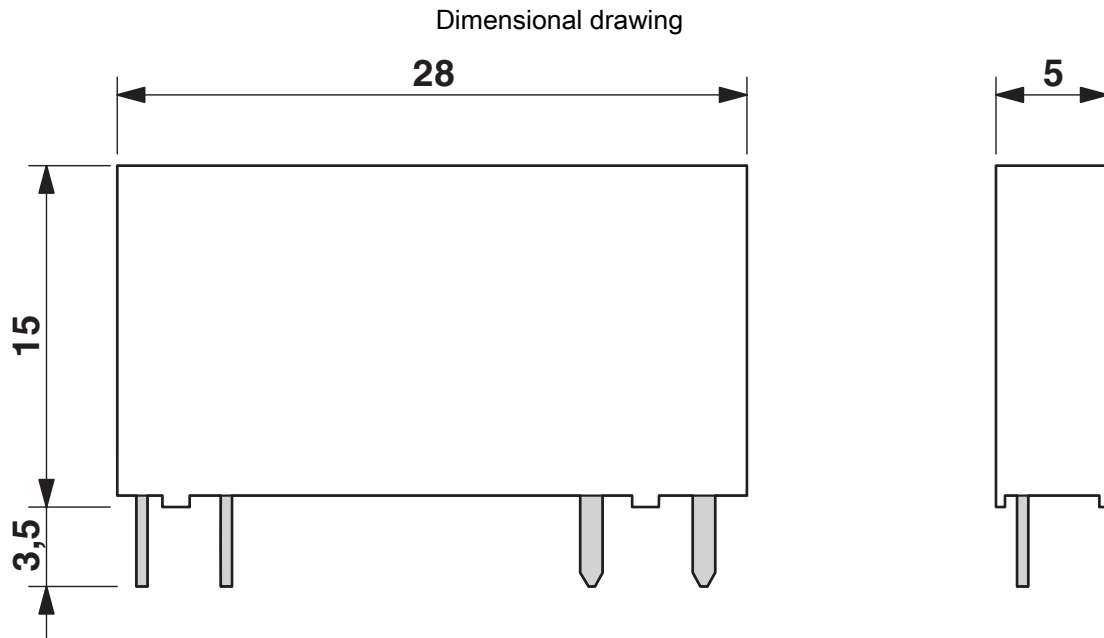

Drilling plan/solder pad geometry

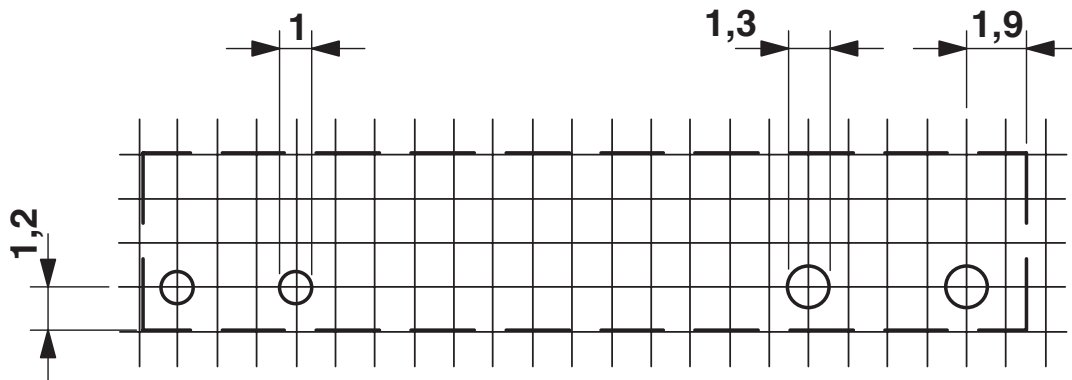

a = pitch division 1.25 mm and 1.27 mm

Miniature solid-state relay - OPT-24DC/ 24DC/ 2



2966595

<https://www.phoenixcontact.com/pc/products/2966595>

Approvals



cUL Recognized
Approval ID: FILE E 195083



UL Recognized
Approval ID: FILE E 195083



EAC
Approval ID: TR_TS_D_00573_c



UL Recognized
Approval ID: FILE E 195083



PRS
Approval ID: TE/2109/880590/16



cUL Recognized
Approval ID: FILE E 195083



GL
Approval ID: 46016-03 HH

Nominal Voltage U_N

Nominal Current I_N

Cross Section AWG

Cross Section mm^2

-

-

Miniature solid-state relay - OPT-24DC/ 24DC/ 2



2966595

<https://www.phoenixcontact.com/pc/products/2966595>

Classifications

ECLASS

ECLASS-9.0	27371604
ECLASS-10.0.1	27371604
ECLASS-11.0	27371604

ETIM

ETIM 8.0	EC001504
----------	----------

UNSPSC

UNSPSC 21.0	39122300
-------------	----------

Miniature solid-state relay - OPT-24DC/ 24DC/ 2



2966595

<https://www.phoenixcontact.com/pc/products/2966595>

Environmental Product Compliance

China RoHS	Environmentally friendly use period: unlimited = EFUP-e
	No hazardous substances above threshold values

Miniature solid-state relay - OPT-24DC/ 24DC/ 2

2966595

<https://www.phoenixcontact.com/pc/products/2966595>

Accessories

Relay base

Relay base - PLC-BPT- 24DC/21 - 2900445

<https://www.phoenixcontact.com/pc/products/2900445>



6.2 mm PLC basic terminal block with Push-in connection, without relay or solid-state relay, for mounting on DIN rail NS 35/7,5, 1 changeover contact, input voltage 24 V DC

Relay base

Relay base - PLC-BSC- 24DC/21 - 2966016

<https://www.phoenixcontact.com/pc/products/2966016>



6.2 mm PLC basic terminal block with screw connection, without relay or solid-state relay, for mounting on DIN rail NS 35/7,5, 1 changeover contact, input voltage 24 V DC

Miniature solid-state relay - OPT-24DC/ 24DC/ 2

2966595

<https://www.phoenixcontact.com/pc/products/2966595>

Relay base

Relay base - PLC-BPT- 48DC/21 - 2900447

<https://www.phoenixcontact.com/pc/products/2900447>



6.2 mm PLC basic terminal block with Push-in connection, without relay or solid-state relay, for mounting on DIN rail NS 35/7,5, 1 changeover contact, input voltage 48 V DC

Relay base

Relay base - PLC-BSC- 48DC/21 - 2966090

<https://www.phoenixcontact.com/pc/products/2966090>



6.2 mm PLC basic terminal block with screw connection, without relay or solid-state relay, for mounting on DIN rail NS 35/7,5, 1 changeover contact, input voltage 48 V DC

Miniature solid-state relay - OPT-24DC/ 24DC/ 2

2966595

<https://www.phoenixcontact.com/pc/products/2966595>

Relay base

Relay base - PLC-BPT- 24DC/ 1/SEN - 2900262

<https://www.phoenixcontact.com/pc/products/2900262>



6.2 mm PLC basic terminal block for input functions with push-in connection, without relay or solid-state relay, for mounting on DIN rail NS 35/7,5, with sensor supply voltage distribution (BB), 1 N/O contact, input voltage 24 V DC

Relay base

Relay base - PLC-BSC- 24DC/ 1/SEN - 2966061

<https://www.phoenixcontact.com/pc/products/2966061>



6.2 mm PLC basic terminal block for input functions with screw connection, without relay or solid-state relay, for mounting on DIN rail NS 35/7,5, with sensor supply voltage distribution (BB), 1 N/O contact, input voltage 24 V DC

Miniature solid-state relay - OPT-24DC/ 24DC/ 2

2966595

<https://www.phoenixcontact.com/pc/products/2966595>

Relay base

Relay base - PLC-BPT- 24DC/ 1/ACT - 2900449

<https://www.phoenixcontact.com/pc/products/2900449>



6.2 mm PLC basic terminal block for output functions with push-in connection, without relay or solid-state relay, for mounting on DIN rail NS 35/7,5, with load return line connection (BB), 1 N/O contact, input voltage 24 V DC

Relay base

Relay base - PLC-BSC- 24DC/ 1/ACT - 2966058

<https://www.phoenixcontact.com/pc/products/2966058>



6.2 mm PLC basic terminal block for output functions with screw connection, without relay or solid-state relay, for mounting on DIN rail NS 35/7,5, with load return line connection (BB), 1 N/O contact, input voltage 24 V DC

Miniature solid-state relay - OPT-24DC/ 24DC/ 2

2966595

<https://www.phoenixcontact.com/pc/products/2966595>

Relay base

Relay base - PLC-BPT- 24UC/ 1/ACT - 2900450

<https://www.phoenixcontact.com/pc/products/2900450>



6.2 mm PLC basic terminal block for output functions with push-in connection, without relay or solid-state relay, for mounting on DIN rail NS 35/7,5, with load return line connection (BB), 1 N/O contact, input voltage 24 V AC/DC

Relay base

Relay base - PLC-BSC- 24UC/ 1/ACT - 2982799

<https://www.phoenixcontact.com/pc/products/2982799>



6.2 mm PLC basic terminal block for output functions with screw connection, without relay or solid-state relay, for mounting on DIN rail NS 35/7,5, with load return line connection (BB), 1 N/O contact, input voltage 24 V AC/DC

Miniature solid-state relay - OPT-24DC/ 24DC/ 2

2966595

<https://www.phoenixcontact.com/pc/products/2966595>

Relay base

Relay base - PLC-BSC- 24DC/21/SO46 - 2980458

<https://www.phoenixcontact.com/pc/products/2980458>



6.2 mm PLC basic terminal block with protection against interference currents/voltages on the control side, with screw connection, without relay or solid-state relay, for mounting on DIN rail NS 35/7,5, with increased input current consumption, 1 changeover contact, input voltage 24 V DC

Relay base

Relay base - RIF-0-BPT/1 - 2901873

<https://www.phoenixcontact.com/pc/products/2901873>

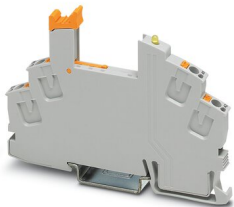

RIF-0... relay base, for miniature power relay with 1 N/O contact or solid-state relays of the same design, push-in connection, for mounting on NS 35/7,5

Miniature solid-state relay - OPT-24DC/ 24DC/ 2



2966595

<https://www.phoenixcontact.com/pc/products/2966595>

Relay base

Relay base - RIF-0-BSC/ 1 - 2901872

<https://www.phoenixcontact.com/pc/products/2901872>

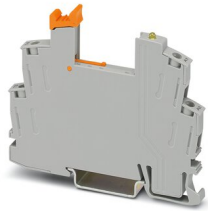

RIF-0... relay base, for miniature power relay with 1 N/O contact or identical solid-state relays, screw connection, for mounting on NS 35/7,5

Phoenix Contact 2022 © - all rights reserved

<https://www.phoenixcontact.com>

PHOENIX CONTACT GmbH & Co. KG

Flachsmarktstraße 8

D-32825 Blomberg

+49 (0) 5235-3 00

info@phoenixcontact.com