

REL-MR-110DC/21-21 - Single relay



2961202

<https://www.phoenixcontact.com/mx/products/2961202>

Please be informed that the data shown in this PDF document is generated from our online catalog. Please find the complete data in the user documentation. Our general terms of use for downloads are valid.

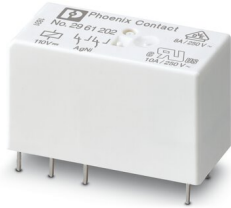

Plug-in miniature power relay, with power contact, 2 changeover contacts, input voltage 110 V DC

Your advantages

- RT III-proof (wash-proof)
- Switching current of up to 8 A

Commercial data

Item number	2961202
Packing unit	10 pc
Minimum order quantity	10 pc
Sales key	05
Product key	CK6195
Catalog page	Page 290 (C-5-2019)
GTIN	4017918158002
Weight per piece (including packing)	17 g
Weight per piece (excluding packing)	16.125 g
Customs tariff number	85364999
Country of origin	AT

REL-MR-110DC/21-21 - Single relay



2961202

<https://www.phoenixcontact.com/mx/products/2961202>

Technical data

Product properties

Product type	Single relay
Operating mode	100% operating factor
Mechanical service life	3x 10 ⁷ cycles

Insulation characteristics

Insulation	Basic insulation
------------	------------------

Insulation characteristics

Insulation	Basic insulation
Overvoltage category	III
Pollution degree	3

Electrical properties

Service life electrical	see diagram
Maximum power dissipation for nominal condition	0.45 W
Test voltage (Winding/contact)	5 kV AC (50 Hz, 1 min., winding/contact)
Test voltage (Contact/contact)	2.5 kV AC (50 Hz, 1 min., contact/contact)

Input data

Coil side

Nominal input voltage U _N	110 V DC
Input voltage range	71.5 V DC ... 272.8 V DC
Drive and function	monostable
Drive (polarity)	non-polarized
Typical input current at U _N	4.1 mA
Typical response time	7 ms
Typical release time	3 ms
Coil resistance	26600 Ω ±15 % (at 20 °C)

Output data

Switching

Contact switching type	2 changeover contacts
Type of switch contact	Single contact
Contact material	AgNi
Maximum switching voltage	250 V AC/DC
Minimum switching voltage	5 V (at 10 mA)
Limiting continuous current	8 A
Maximum inrush current	25 A (20 ms)
Min. switching current	10 mA (At 5 V)
	190 W (at 24 V DC)

REL-MR-110DC/21-21 - Single relay

2961202

<https://www.phoenixcontact.com/mx/products/2961202>

Interrupting rating (ohmic load) max.	85 W (at 48 V DC)
	60 W (at 60 V DC)
	44 W (at 110 V DC)
	60 W (at 220 V DC)
	2000 VA (for 250 V AC)
Switching capacity	2 A (at 24 V, DC13)
	0.2 A (at 250 V, DC13)
	3 A (at 24 V, AC15)
	3 A (at 120 V, AC15)
	3 A (at 250 V, AC15)
Motor load according to UL 508	1/4 HP, 120 V AC
	1/2 HP, 240 V AC

Connection data

Connection method	Plug / solder connection
-------------------	--------------------------

Dimensions

Dimensional drawing	
Width	12.7 mm
Height	29 mm
Depth	15.7 mm

Environmental and real-life conditions

Ambient conditions

Degree of protection	RT III
Ambient temperature (operation)	-40 °C ... 85 °C
Ambient temperature (storage/transport)	-40 °C ... 85 °C

Approvals

Corrosive gas test

Identification	ISA-S71.04. G3 Harsh Group EN 60068-2-60
----------------	---

Standards and regulations

Standards/regulations	IEC 60664 EN 50178 EN 61810-1
-----------------------	-------------------------------------

Mounting

Assembly instructions	Can be aligned without spacing (> 70 °C ≥ 2.5 mm)
-----------------------	---

REL-MR-110DC/21-21 - Single relay



2961202

<https://www.phoenixcontact.com/mx/products/2961202>

Mounting position	any
-------------------	-----

Drawings

Diagram

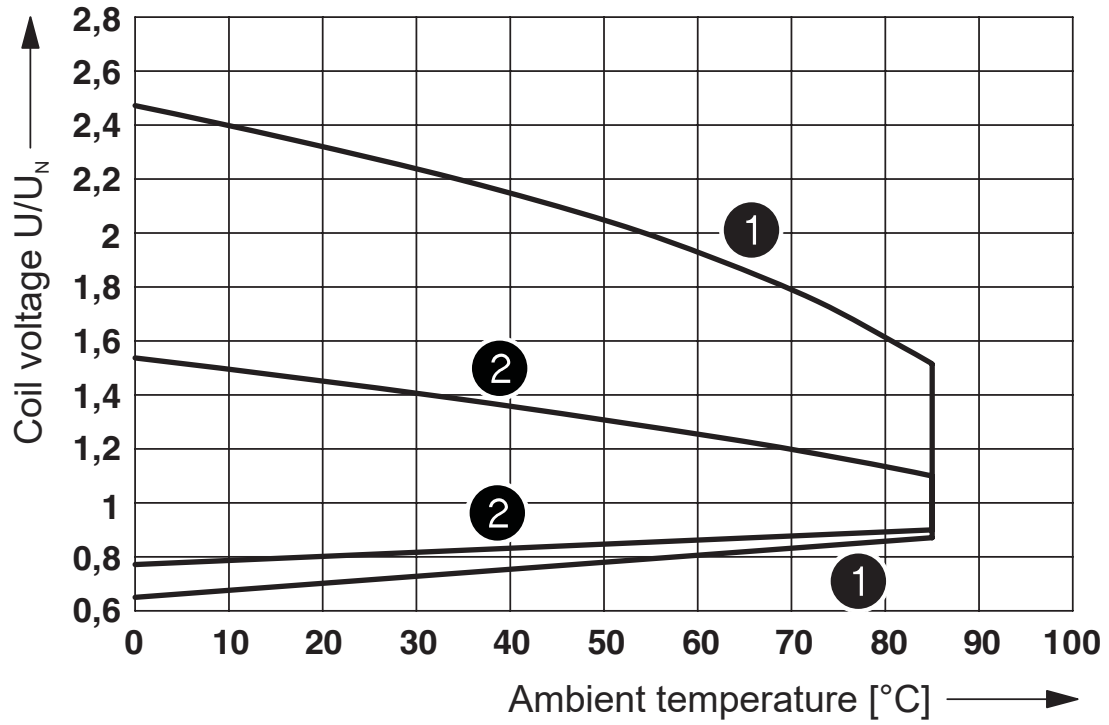

- ① DC coils
- ② AC coils

Operating voltage range

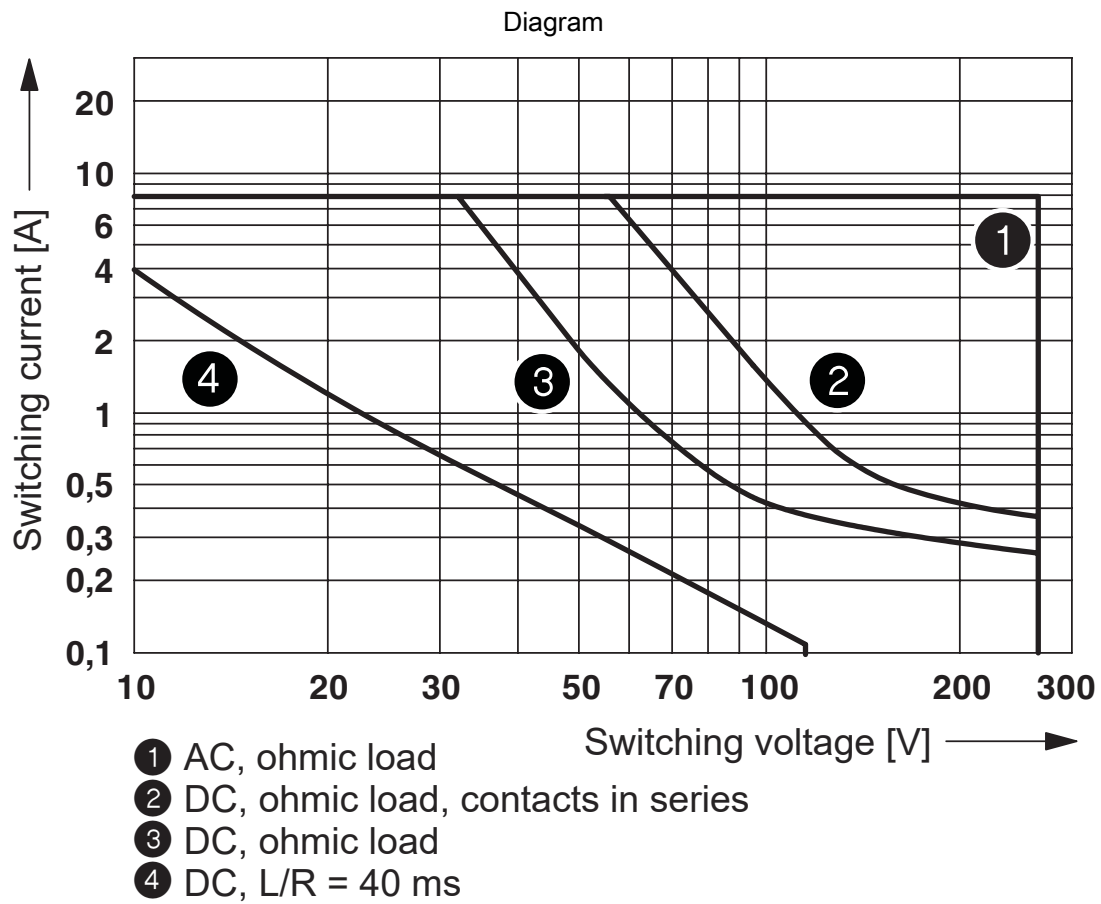

Interrupting rating

Diagram

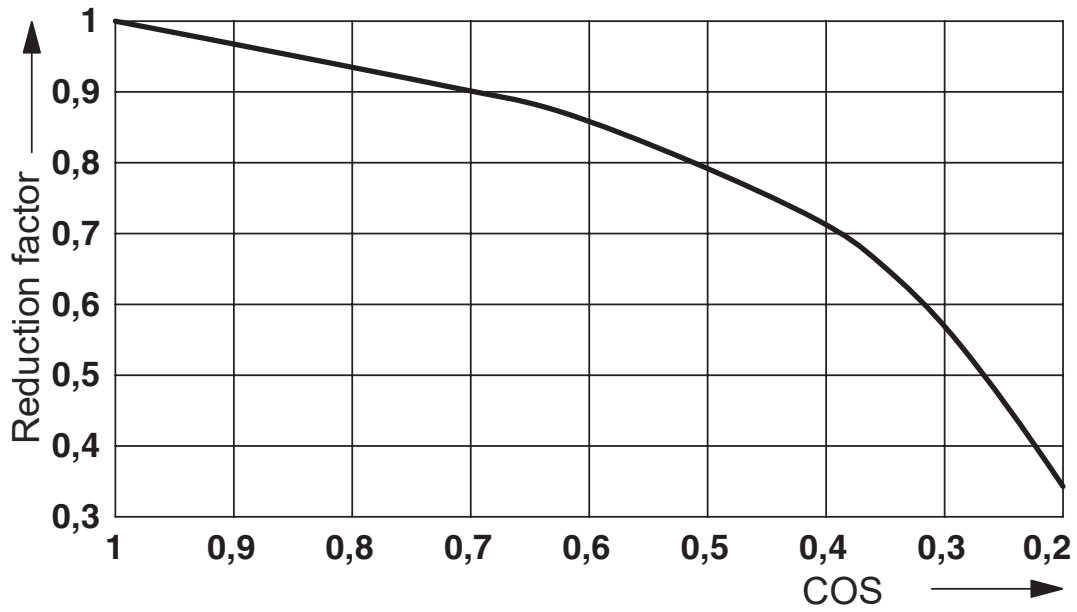

Service life reduction factor with various cos phi

Dimensional drawing

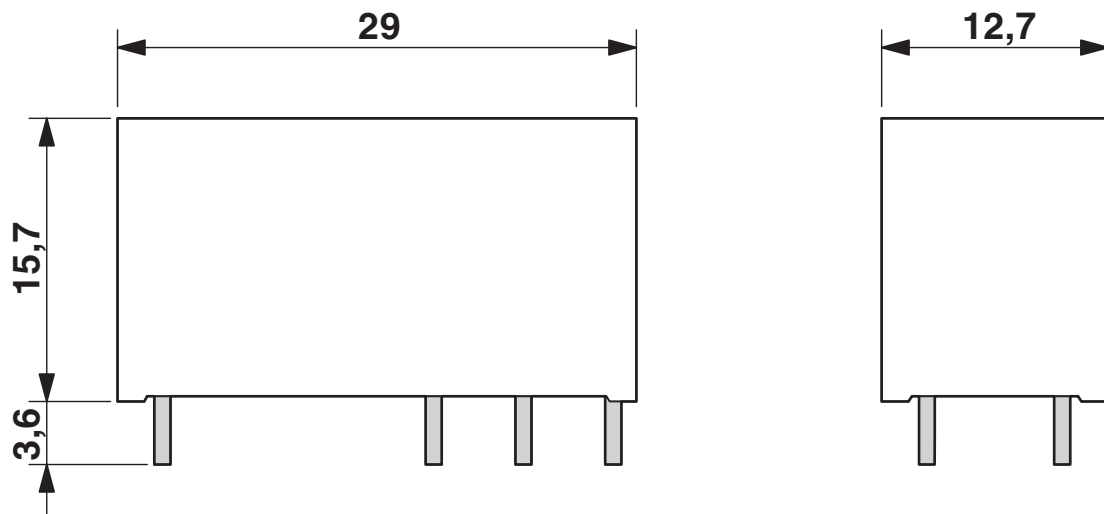

REL-MR-110DC/21-21 - Single relay

2961202

<https://www.phoenixcontact.com/mx/products/2961202>

Circuit diagram

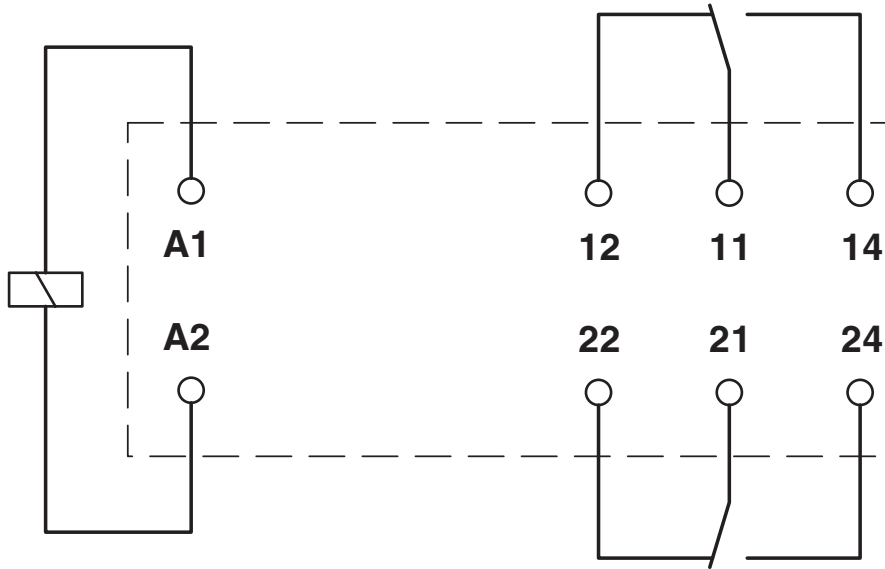

Drilling plan/solder pad geometry

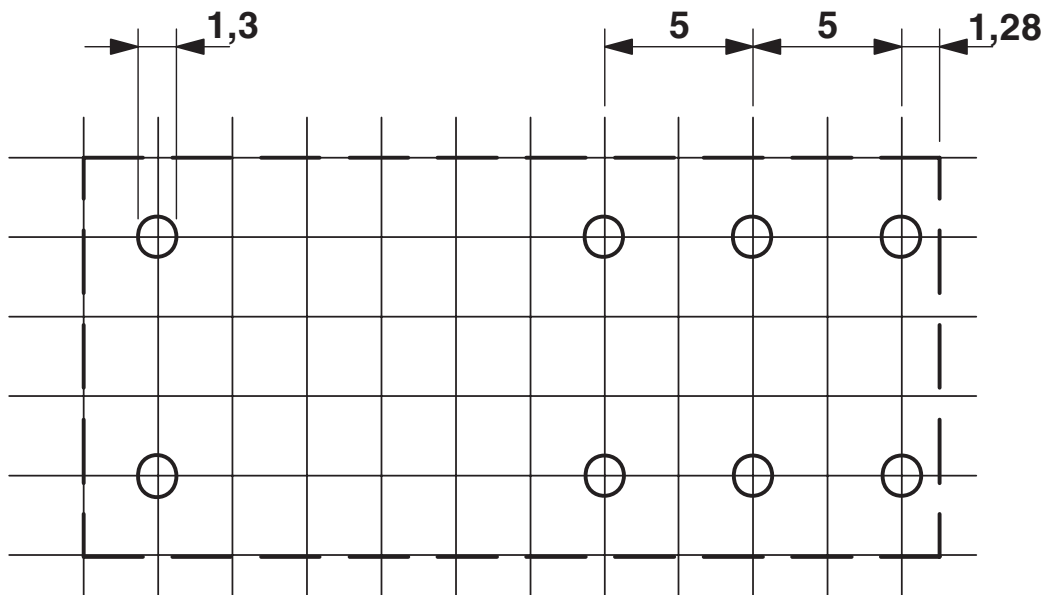

a = pitch division 2.5 mm

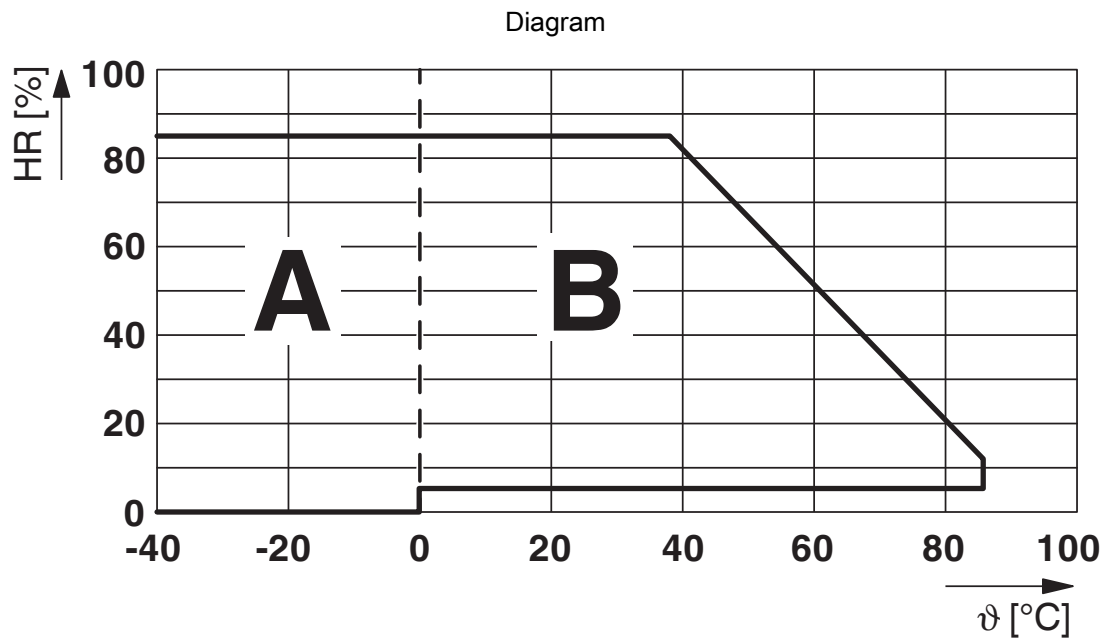

Permissible humidity for operation and storage.

The maximum permissible ambient temperature as specified in the data sheet must be observed.

Area A: Ice buildup at ambient temperatures $\leq 0^\circ\text{C}$ must be prevented

Area B: Condensation at ambient temperatures $> 0^\circ\text{C}$ must be prevented

On 30 full days that are naturally distributed across an entire year, a humidity level of 95% is permissible at an ambient temperature $\leq 25^\circ\text{C}$.

Diagram

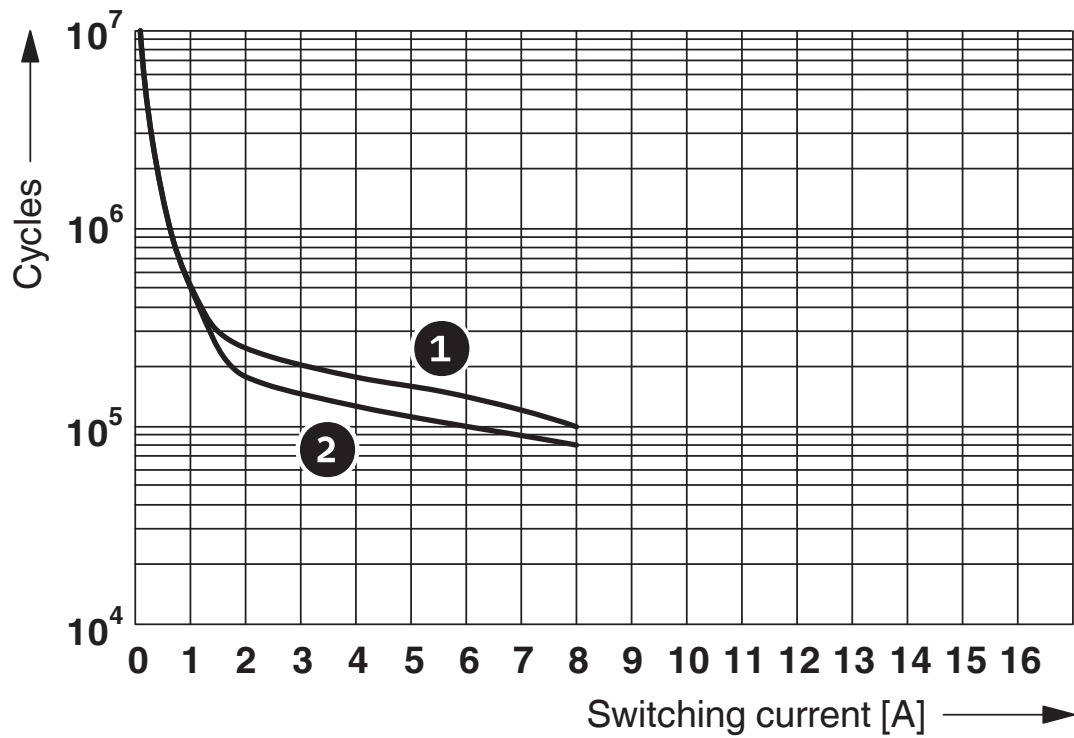

- 1 250 V AC, ohmic load (DC coils)
- 2 250 V AC, ohmic load (AC coils)

Electrical service life

REL-MR-110DC/21-21 - Single relay



2961202

<https://www.phoenixcontact.com/mx/products/2961202>

Approvals

To download certificates, visit the product detail page: <https://www.phoenixcontact.com/mx/products/2961202>



cUL Recognized
Approval ID: FILE E 228652



UL Recognized
Approval ID: FILE E 228652



EAC
Approval ID: TR_TS_D_00573_c



UL Recognized
Approval ID: FILE E 228652



EAC
Approval ID: RU*C-DE.*08.B.00010



VDE Zeichengenehmigung
Approval ID: 40007758



cUL Recognized
Approval ID: FILE E 228652

REL-MR-110DC/21-21 - Single relay



2961202

<https://www.phoenixcontact.com/mx/products/2961202>

Classifications

ECLASS

ECLASS-11.0	27371601
ECLASS-12.0	27371601
ECLASS-13.0	27371601

ETIM

ETIM 8.0	EC001437
----------	----------

UNSPSC

UNSPSC 21.0	39122300
-------------	----------

REL-MR-110DC/21-21 - Single relay



2961202

<https://www.phoenixcontact.com/mx/products/2961202>

Environmental product compliance

China RoHS	Environmentally friendly use period: unlimited = EFUP-e
	No hazardous substances above threshold values

REL-MR-110DC/21-21 - Single relay

2961202

<https://www.phoenixcontact.com/mx/products/2961202>

Accessories

RIF-1-BPT/2X21 - Relay base

2900931

<https://www.phoenixcontact.com/mx/products/2900931>



Relay base RIF-1..., for miniature power relay with 1 or 2 changeover contacts or solid-state relays of the same design, Push-in connection, plug-in option for input/interference suppression modules, for mounting on NS 35/7,5

RIF-1-BSC/2X21 - Relay base

2900930

<https://www.phoenixcontact.com/mx/products/2900930>

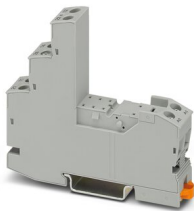

RIF-1... relay base, for miniature power relay with 1 or 2 changeover contacts or identical solid-state relays, screw connection, plug-in option for input/interference suppression modules, for mounting on NS 35/7,5

REL-MR-110DC/21-21 - Single relay

2961202

<https://www.phoenixcontact.com/mx/products/2961202>



PLC-BPT-120UC/21-21 - Relay base

2900287

<https://www.phoenixcontact.com/mx/products/2900287>



14 mm PLC basic terminal block with Push-in connection, without relay or solid-state relay, for mounting on DIN rail NS 35/7,5, 2 changeover contacts, input voltage 120 V AC/DC

PLC-BSC-120UC/21-21 - Relay base

2967031

<https://www.phoenixcontact.com/mx/products/2967031>



14 mm PLC basic terminal block with screw connection, without relay or solid-state relay, for mounting on DIN rail NS 35/7,5, 2 changeover contacts, input voltage 120 V AC/DC

REL-MR-110DC/21-21 - Single relay

2961202

<https://www.phoenixcontact.com/mx/products/2961202>

PLC-BPT-230UC/21-21 - Relay base

2900288

<https://www.phoenixcontact.com/mx/products/2900288>



14 mm PLC basic terminal block with Push-in connection, without relay or solid-state relay, for mounting on DIN rail NS 35/7,5, 2 changeover contacts, input voltage 230 V AC/DC

PLC-BSC-230UC/21-21 - Relay base

2967044

<https://www.phoenixcontact.com/mx/products/2967044>



14 mm PLC basic terminal block with screw connection, without relay or solid-state relay, for mounting on DIN rail NS 35/7,5, 2 changeover contacts, input voltage 230 V AC/DC

REL-MR-110DC/21-21 - Single relay

2961202

<https://www.phoenixcontact.com/mx/products/2961202>



PLC-BSC-120UC/21-21/SO46 - Relay base

2980416

<https://www.phoenixcontact.com/mx/products/2980416>



14 mm PLC basic terminal block with interference current and interference voltage protection on the control side, with screw connection, without relay or solid-state relay, for mounting on DIN rail NS 35/7,5, with integrated RCZ filter, 2 changeover contacts, input voltage 120 V AC

PLC-BSC-230UC/21-21/SO46 - Relay base

2980429

<https://www.phoenixcontact.com/mx/products/2980429>



14 mm PLC basic terminal block with interference current and interference voltage protection on the control side, with screw connection, without relay or solid-state relay, for mounting on DIN rail NS 35/7,5, with integrated RCZ filter, 2 changeover contacts, input voltage 230 V AC

Phoenix Contact 2023 © - all rights reserved
<https://www.phoenixcontact.com>

PHOENIX CONTACT S.A. de C.V.
Lago Alberto No. 319 - Piso 9
Colonia Granada, Delegación Miguel Hidalgo, México, Ciudad de México, C.P. 11520
+52/55/1101-1380
ventas@phoenixcontact.com.mx